

BÉABA®

- F** Notice d'utilisation
- EN** Instructions
- NL** Handleiding
- D** Gebrauchsanweisung
- E** Folleto de Instrucciones
- I** Istruzioni per l'uso
- PL** Instrukcja obsługi
- RU** Инструкция по эксплуатации
- CN** 操作说明书
- CT** 使用說明



COUSSIN DE CHAISE HAUTE
UP & DOWN
HIGH CHAIR CUSHION

F VEUILLEZ LIRE ATTENTIVEMENT LA PRÉSENTE NOTICE ET LA CONSERVER.

AVERTISSEMENT

- Ce produit est adapté à la chaise haute Up & Down Béaba.
- Le montage de l'assise doit toujours être réalisé par un adulte.
- Ne jamais laisser votre enfant seul sans surveillance dans la chaise.
- Toujours utiliser le harnais pour attacher votre enfant.

ENTRETIEN: Lavage à la main ou en machine sur cycle délicat.

EN PLEASE READ THESE INSTRUCTIONS CAREFULLY AND KEEP FOR FUTURE REFERENCE.

CAUTION

- This product is adapted for the Beaba Up & Down highchair
- The seat must be assembled by an adult.
- Never leave a child unsupervised in the chair.
- Always use the harness to secure your child.

CLEANING: hand wash or machine wash on delicate cycle.

NL LEES DEZE HANDLEIDING ZORGVULDIG DOOR EN BEWAAR HET.

WAARSCHUWING

- Dit product is geschikt voor de Up & Down kinderstoel van Béaba.
- Het kussentje moet altijd door een volwassene aangebracht worden.
- Laat uw kindje nooit alleen zonder toezicht in de kinderstoel.
- Gebruik altijd het tuigje om uw kindje vast te zetten.

ONDERHOUD: met de hand wassen of in de wasmachine op het fijnwasprogramma

D BITTE LESEN SIE DIESE GEBRAUCHSANWEISUNG AUFMERKSAM UND BEWAHREN SIE SIE AUF.

WARNHINWEIS

- Dieses Produkt ist für den Hochstuhl Up & Down von Béaba geeignet
- Der Sitz muss stets von einem Erwachsenen angebracht werden.
- Lassen Sie Ihr Kind niemals unbeaufsichtigt im Stuhl.
- Verwenden Sie immer den Sicherheitsgurt, um Ihr Kind festzuschnallen.

WARTUNG: Handwäsche oder Maschinenwäsche im Schonwaschgang

E LEA ATENTAMENTE ESTAS INSTRUCCIONES Y CONSÉRVELAS.

ADVERTENCIA

- Este producto se adapta a la silla de bebé Up & Down Béaba
- El montaje del asiento deberá ser siempre realizado por un adulto.
- No deje nunca al niño solo en la silla sin vigilancia
- Utilice siempre el arnés para sujetar al niño.

LIMPIEZA: lavar a mano o en máquina el ciclo dedicado

I VI PREGHIAMO DI LEGGERE ATTENTAMENTE LE PRESENTI ISTRUZIONI E DI CONSERVARLE.

AVVERTENZE

- Questo prodotto è adatto per il seggiolone Up&Down Béaba.

- Il montaggio della seduta deve sempre essere eseguito da un adulto.
- Non lasciate mai il vostro bambino da solo senza sorveglianza nel seggiolone.
- Utilizzare sempre l'imbracatura per fissare il bambino.

MANUTENZIONE: Lavabile a mano o in lavatrice al ciclo delicati.

P LEIA ATENTAMENTE ESTAS INSTRUÇÕES E GUARDE-AS PARA CONSULTA FUTURA.

CAUIDADO

- Este produto está adaptado para a cadeira alta Up & Down da Béaba
- O assento tem de ser montado por um adulto.
- Nunca deixe uma criança na cadeira sem supervisão.
- Use sempre o cinto para prender a criança.

LIMPEZA: Lavagem à mão ou lavagem na máquina no ciclo para roupa delicada.

PL NALEŻY DOKŁADNIE PRZECZYTAĆ TĘ INSTRUKCJĘ I ZACHOWAĆ JĄ DO WYKORZYSTANIA W PRZYSZŁOŚCI.

OSTRZEŻENIE

- Produkt jest przeznaczony do użycia z wysokim krzesłem dla dzieci Up & Down Béaba
- Montaż siedzenia musi być przeprowadzany przez osobę dorosłą.
- Nie wolno w żadnym wypadku pozostawiać dziecka siedzącego w krześle bez opieki.
- Dziecko powinno mieć zawsze prawidłowo zapięte szelki.

UTRZYMANIE: Prać ręcznie lub w pralce automatycznej na programie dla tkanin delikatnych.

RU ВНИМАТЕЛЬНО ПРОЧИТЕ НАСТОЯЩУЮ ИНСТРУКЦИЮ И СОХРАНИТЕ ЕЕ.

ПРЕДУПРЕЖДЕНИЕ!

- Это изделие предназначено для использования с высоким стулом Up & Down Béaba.
- Установку вставки должны выполнять только взрослые.
- Никогда не оставляйте ребенка одного в стуле без присмотра.
- Всегда используйте ремень для крепления ребенка.

УХОД: Ручная или машинная стирка (в деликатном режиме).

CN 請認真閱讀本說明並妥善保管。

警告

- 本品适用于 Béaba 公司 Up & Down 儿童高脚椅
- 坐垫的安装必须始终由成人完成。
- 请不要在无人监护情况下将孩子独自留在高脚椅中
- 始终使用安全带将您的孩子固定在座椅上。

清洗: 手洗或温和洗衣程序机洗

CT 請詳細閱讀本說明並妥善保管。

警告

- 本品適用於 Béaba 公司的 Up & Down 兒童高腳椅
- 須由成人完成座墊的安裝。
- 請勿在無人監護情況下，讓孩子獨自留在高腳椅中
- 請務必使用安全帶，將您的孩子固定在座椅上。

洗滌方式: 請以手洗或洗衣機的溫和行程機洗。

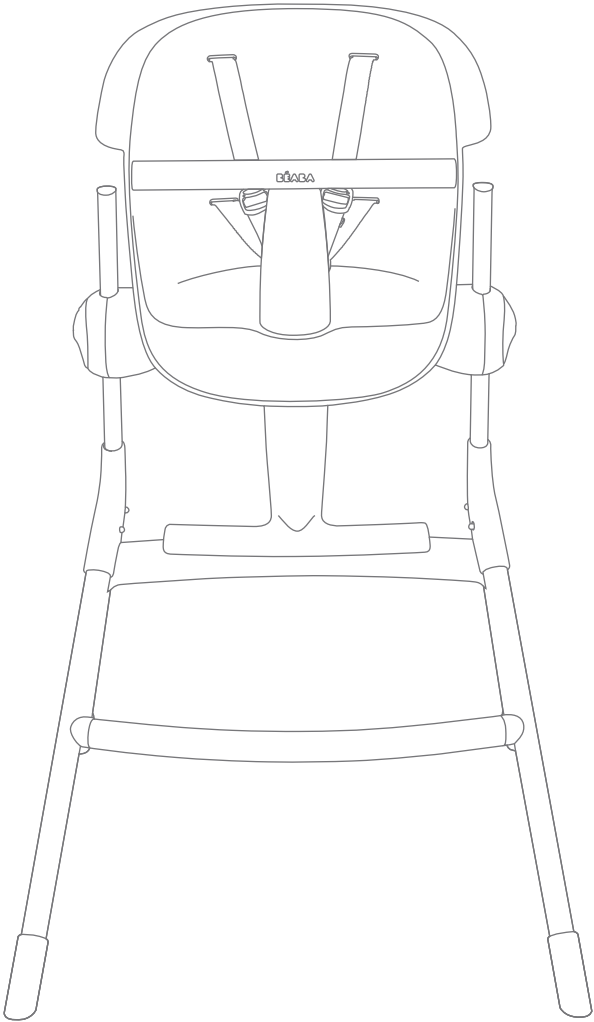

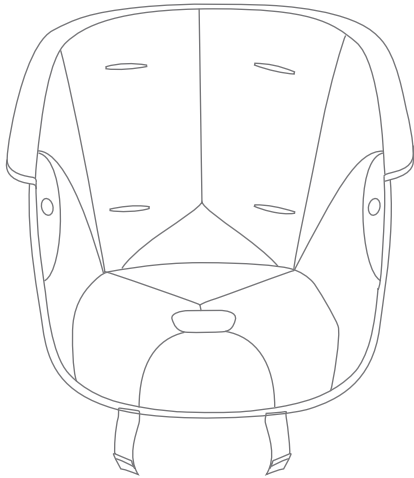

1

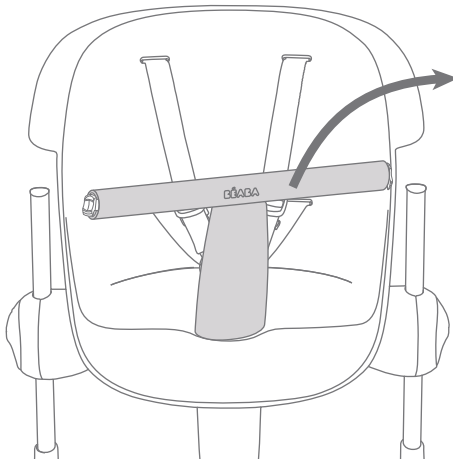
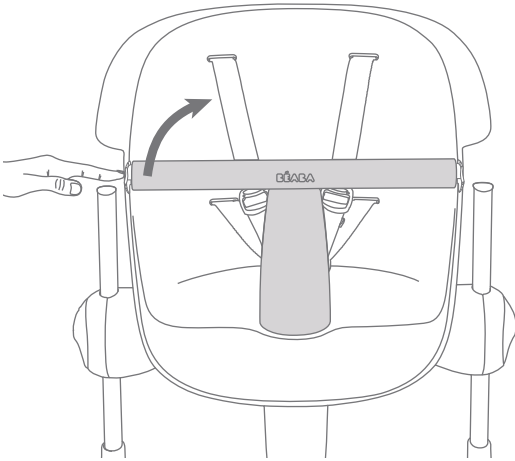

2

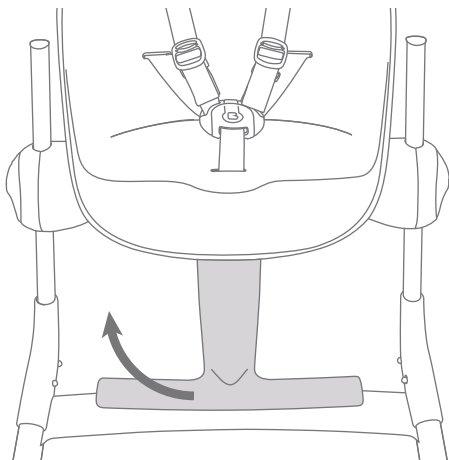

3

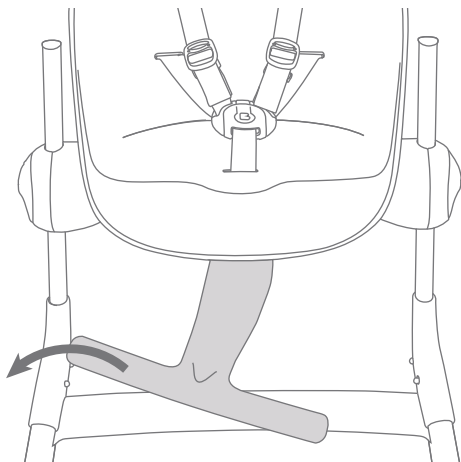

4

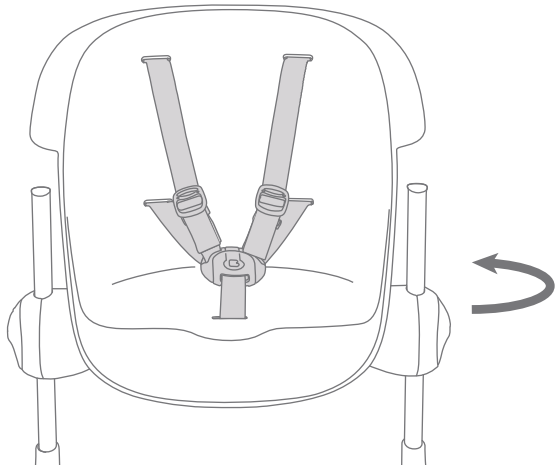

5

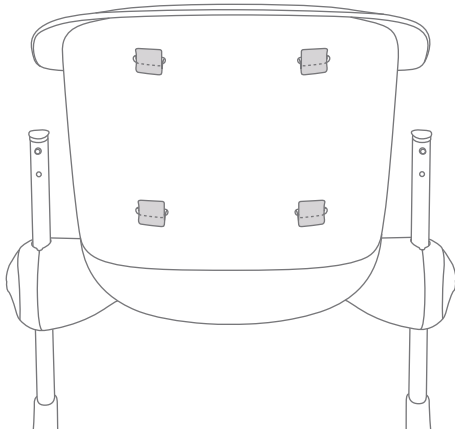

6

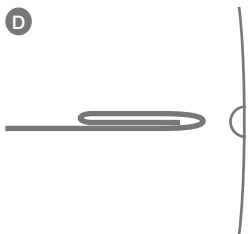
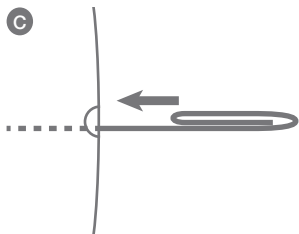
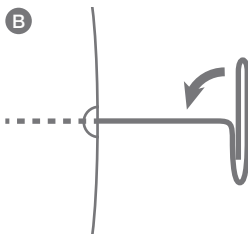
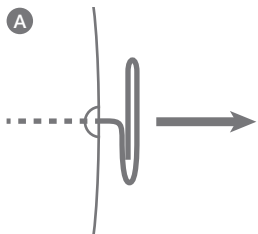
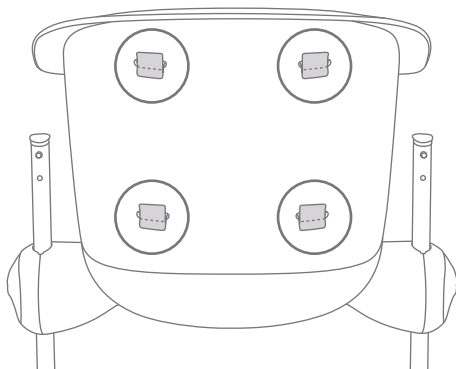

7

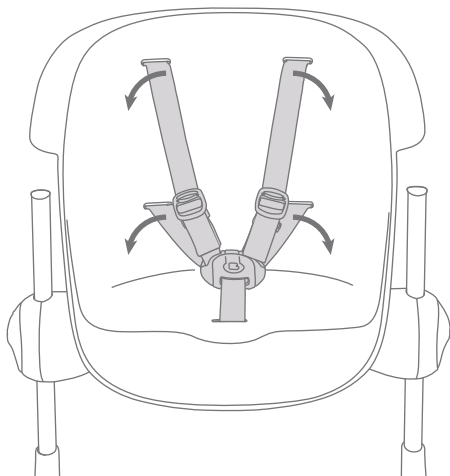

8

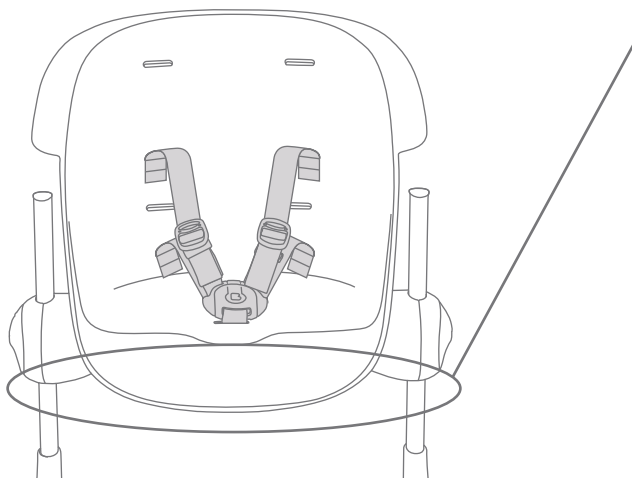

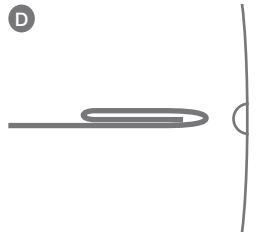
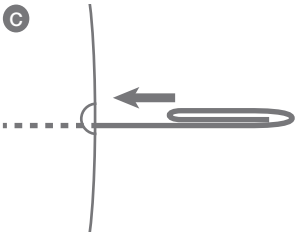
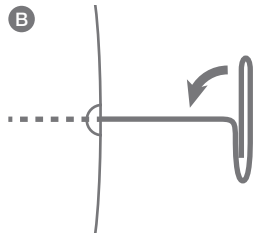
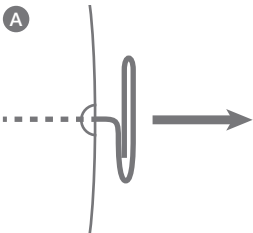
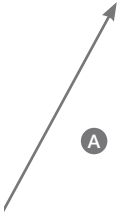
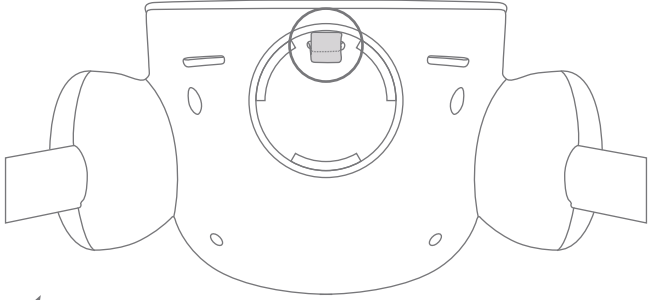

9

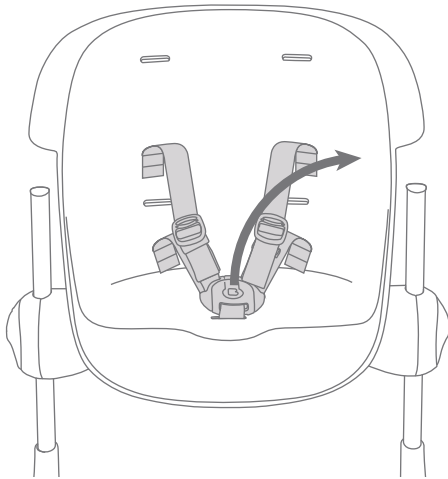

10

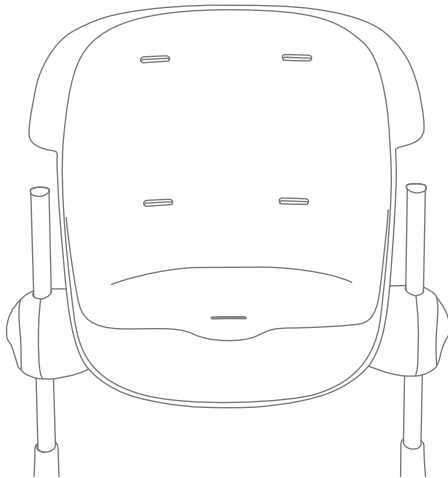

11

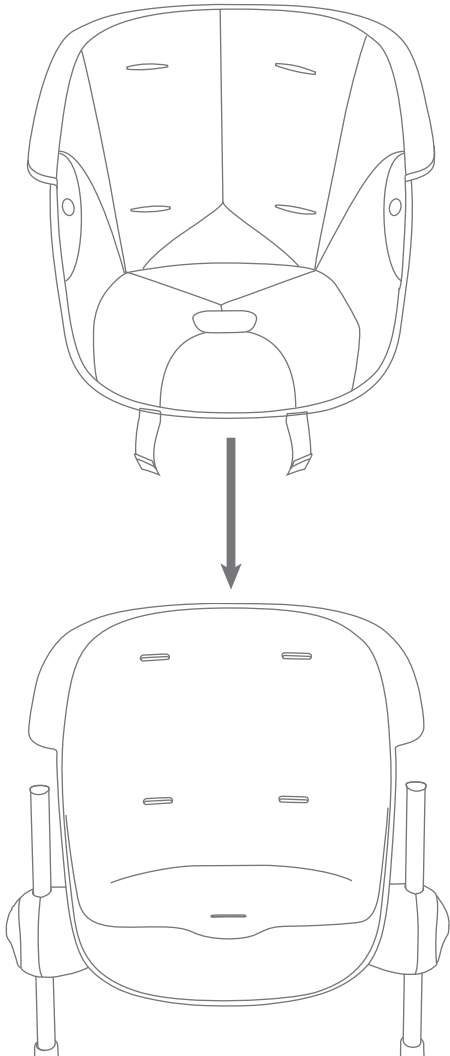

12

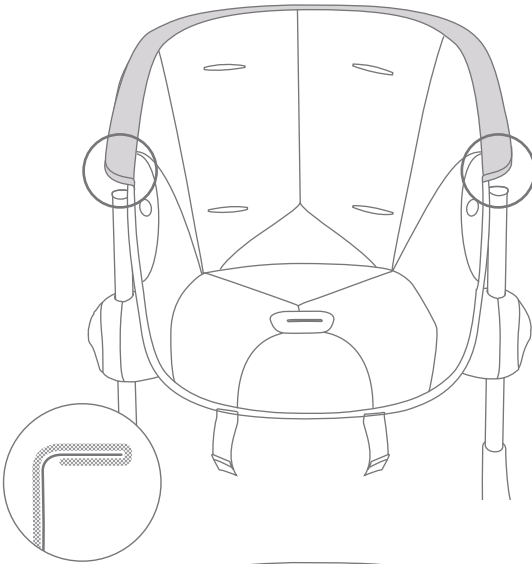

13

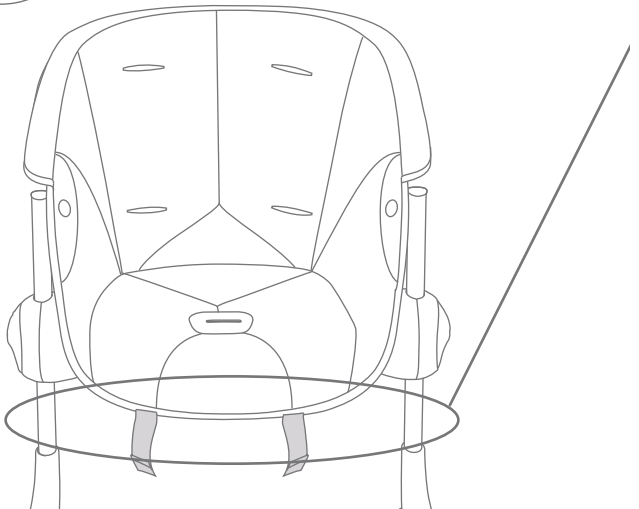

14

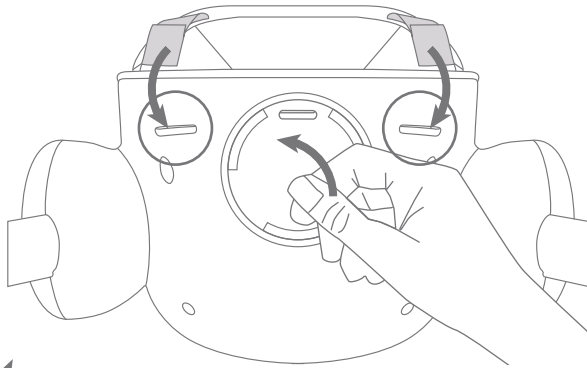

A

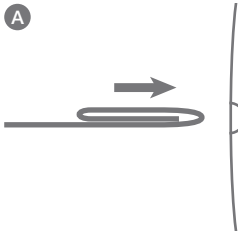

B

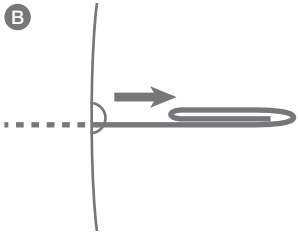

C

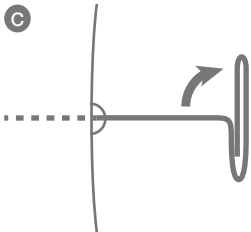

D

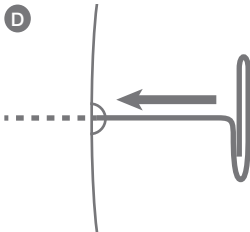

15

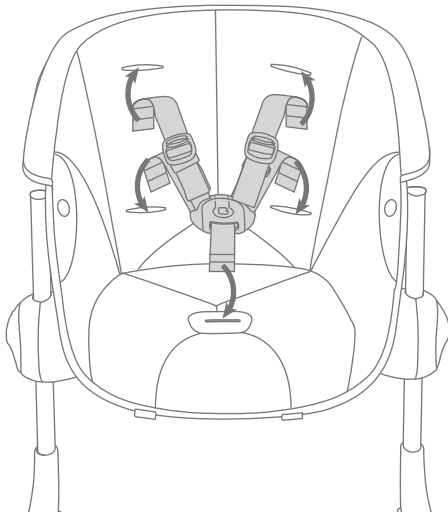

A

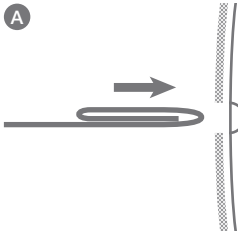

B

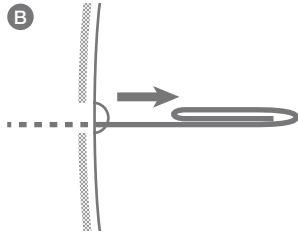

C

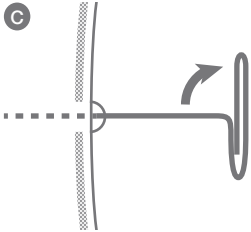

D

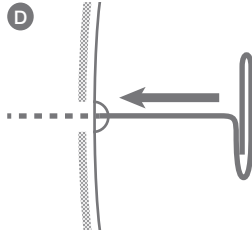

16

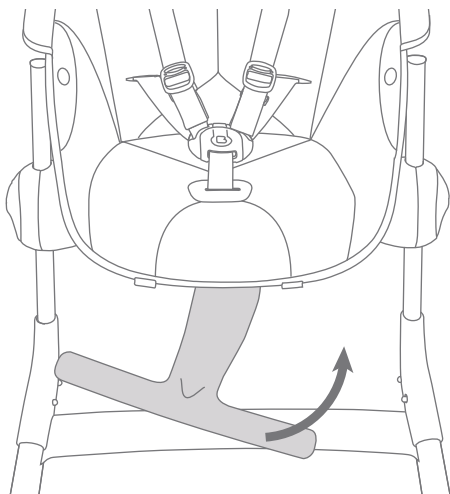

17

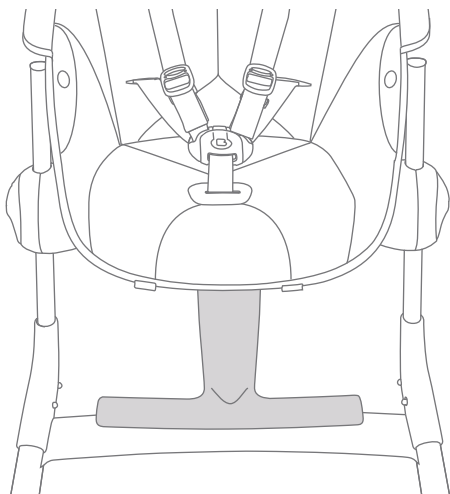

18

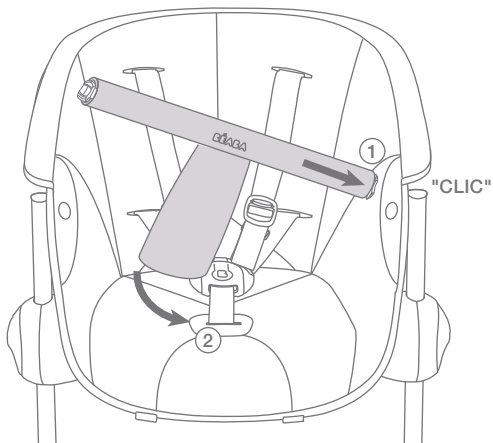

19

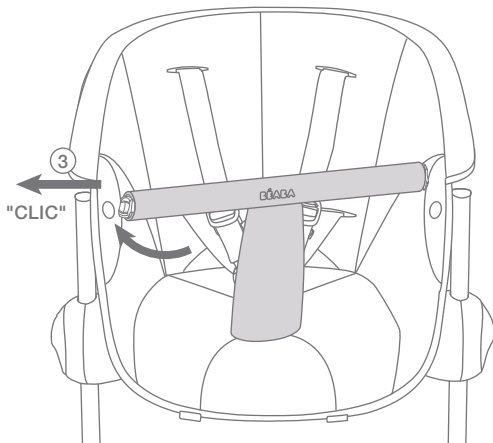

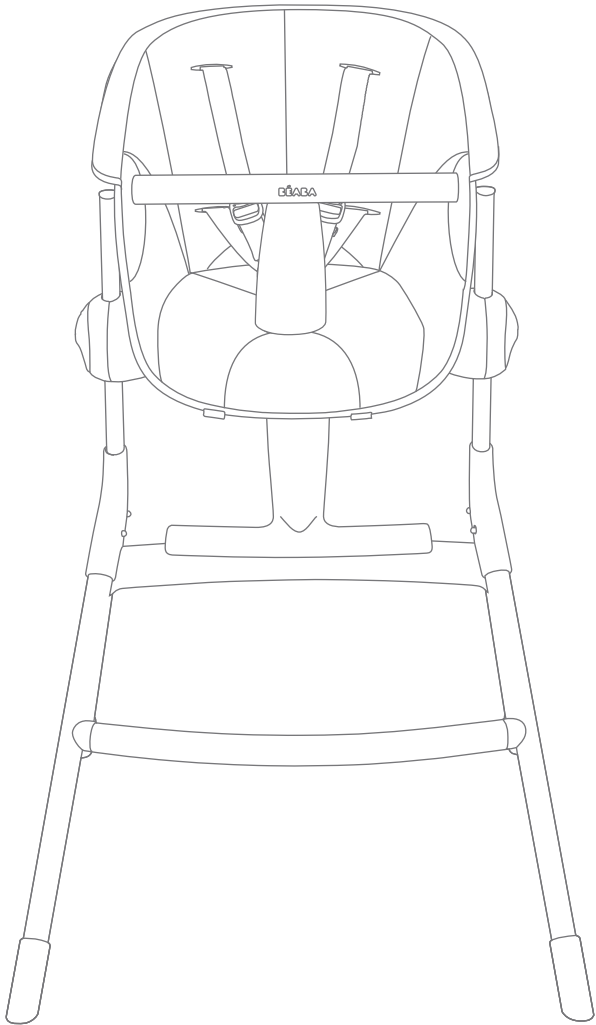

BÉABA
37 rue de Liège
75008 Paris
FRANCE

MADE IN CHINA

www.beaba.com



Pour activer votre garantie,
télécharger l'application
Béaba & Moi sur App Store ou
Google play.



To activate your guarantee,
download the Béaba & Me
application on App Store or
Google play.

0720